

S9013 TRANSISTOR (NPN)

FEATURES

- Complementary to S9012
- Excellent h_{FE} linearity

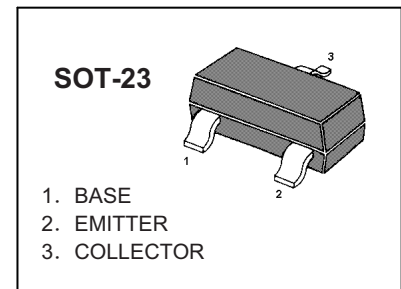

MARKING: J3

MAXIMUM RATINGS ($T_A=25^\circ\text{C}$ unless otherwise noted)

Symbol	Parameter	Value	Units
V_{CBO}	Collector-Base Voltage	40	V
V_{CEO}	Collector-Emitter Voltage	25	V
V_{EBO}	Emitter-Base Voltage	5	V
I_C	Collector Current -Continuous	500	mA
P_C	Collector Power Dissipation	300	mW
T_j	Junction Temperature	150	$^\circ\text{C}$
T_{stg}	Storage Temperature	-55-150	$^\circ\text{C}$

ELECTRICAL CHARACTERISTICS ($T_{amb}=25^\circ\text{C}$ unless otherwise specified)

Parameter	Symbol	Test conditions	MIN	TYP	MAX	UNIT
Collector-base breakdown voltage	$V_{(BR)CBO}$	$I_C=100\mu\text{A}$, $I_E=0$	40			V
Collector-emitter breakdown voltage	$V_{(BR)CEO}$	$I_C=0.1\text{mA}$, $I_B=0$	25			V
Emitter-base breakdown voltage	$V_{(BR)EBO}$	$I_E=100\mu\text{A}$, $I_C=0$	5			V
Collector cut-off current	I_{CBO}	$V_{CB}=40\text{V}$, $I_E=0$			0.1	μA
Collector cut-off current	I_{CEO}	$V_{CE}=20\text{V}$, $I_B=0$			0.1	μA
Emitter cut-off current	I_{EBO}	$V_{EB}=5\text{V}$, $I_C=0$			0.1	μA
DC current gain	$h_{FE(1)}$	$V_{CE}=1\text{V}$, $I_C=50\text{mA}$	120		200	
	$h_{FE(2)}$	$V_{CE}=1\text{V}$, $I_C=500\text{mA}$	40			
Collector-emitter saturation voltage	$V_{CE(sat)}$	$I_C=500\text{mA}$, $I_B=50\text{mA}$			0.6	V
Base-emitter saturation voltage	$V_{BE(sat)}$	$I_C=500\text{mA}$, $I_B=50\text{mA}$			1.2	V
Transition frequency	f_T	$V_{CE}=6\text{V}$, $I_C=20\text{mA}$ $f=30\text{MHz}$	150			MHz

Typical Characteristics

S9013

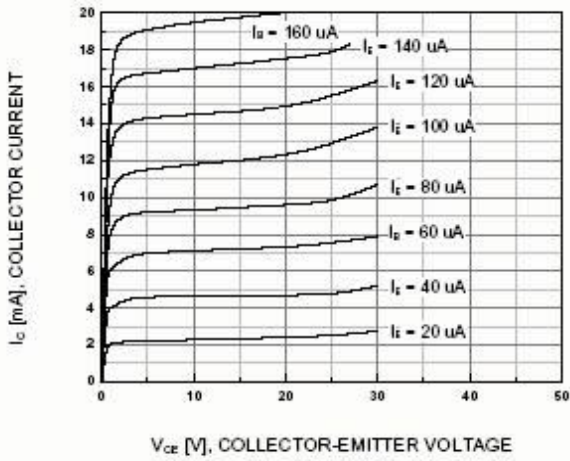

Figure 1. Static Characteristic

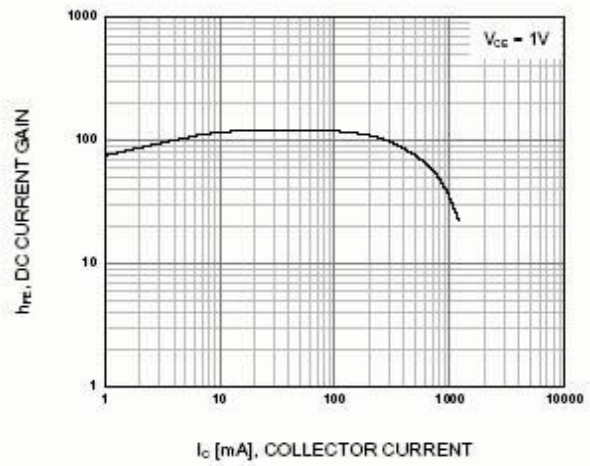

Figure 2. DC current Gain

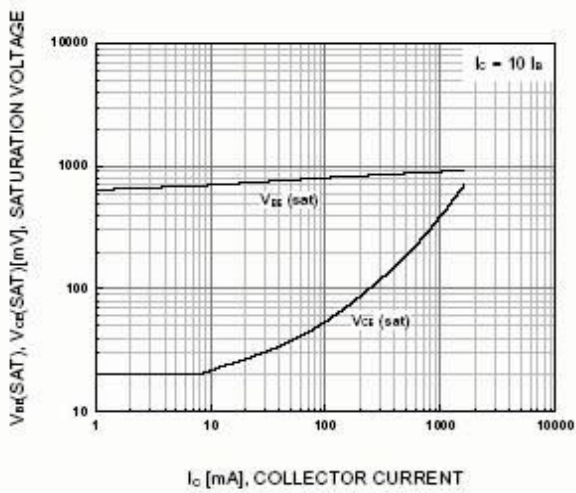

Figure 3. Base-Emitter Saturation Voltage
Collector-Emitter Saturation Voltage

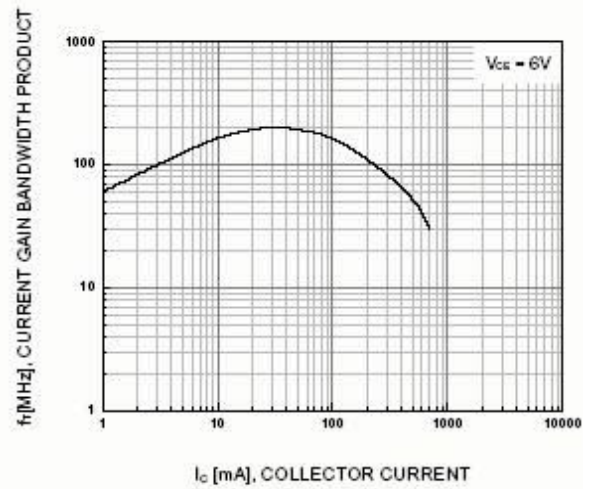
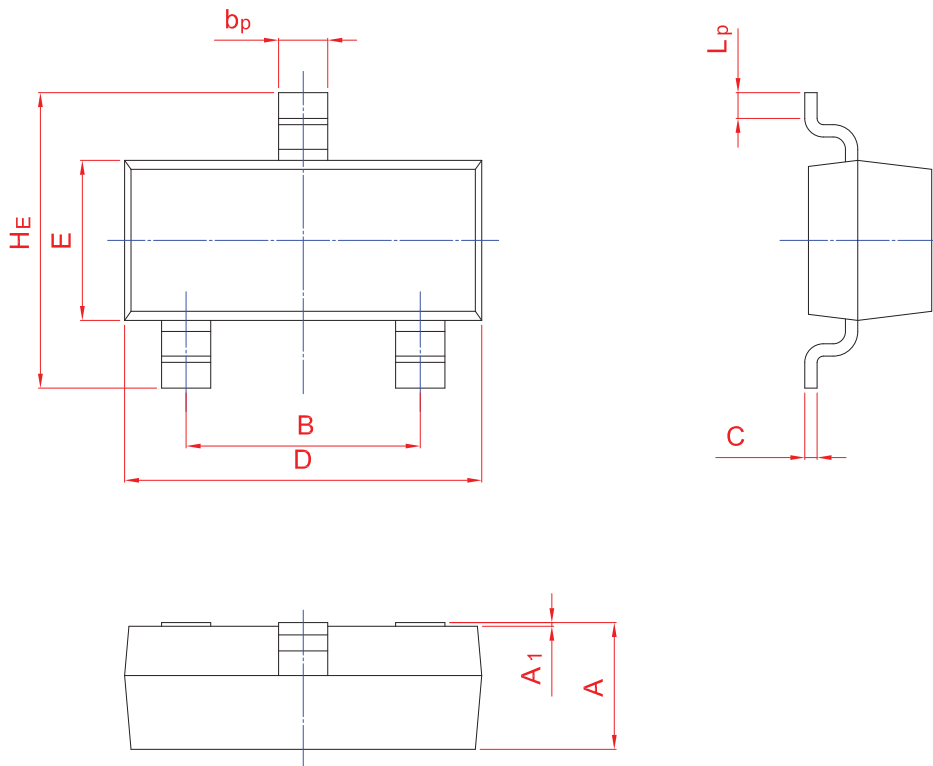
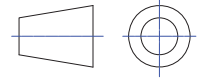

Figure 4. Current Gain Bandwidth Product

PACKAGE OUTLINE

Plastic surface mounted package; 3 leads

SOT-23



UNIT	A	B	b _p	C	D	E	H _E	A ₁	L _p
mm	1.40	2.04	0.50	0.19	3.10	1.65	3.00	0.100	0.50
	0.95	1.78	0.35	0.08	2.70	1.20	2.20	0.013	0.20