

SOT-89 Plastic-Encapsulate Transistors

BCX54,BCX55,BCX56 TRANSISTOR (NPN)

FEATURES

- PNP Complements to BCX51,BCX52,BCX53
- Low Voltage
- High Current

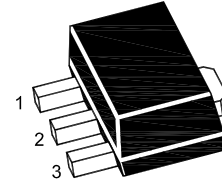

1.Base 2.Collector 3.Emitter
SOT-89 Plastic Package

APPLICATIONS

- Driver Stages of Audio Amplifiers

MARKING:BCX54:BA, BCX54-10:BC, BCX54-16:BD
BCX55:BE, BCX55-10:BG, BCX55-16BM
BCX56:B H, BCX56-10:BK, BCX56-16:BL

MAXIMUM RATINGS ($T_a=25^{\circ}\text{C}$ unless otherwise noted)

Symbol	Parameter		Value	Unit
V_{CBO}	Collector-Base Voltage	BCX54	45	V
		BCX55	60	
		BCX56	100	
V_{CEO}	Collector-Emitter Voltage	BCX54	45	V
		BCX55	60	
		BCX56	80	
V_{EBO}	Emitter-Base Voltage		5	V
I_C	Collector Current		1	A
P_C	Collector Power Dissipation		500	mW
$R_{\theta JA}$	Thermal Resistance From Junction To Ambient		250	$^{\circ}\text{C}/\text{W}$
T_j	Junction Temperature		150	$^{\circ}\text{C}$
T_{stg}	Storage Temperature		-55~+150	$^{\circ}\text{C}$

Parameter	Symbol	Test conditions	Min	Typ	Max	Unit
Collector-base breakdown voltage	$V_{(BR)CBO}$	$I_C=100\mu A, I_E=0$	BCX54	45		V
			BCX55	60		
			BCX56	100		
Collector-emitter breakdown voltage	$V_{(BR)CEO^*}$	$I_C=10mA, I_B=0$	BCX54	45		V
			BCX55	60		
			BCX56	80		
Emitter-base breakdown voltage	$V_{(BR)EBO}$	$I_E=100\mu A, I_C=0$	5			V
Collector cut-off current	I_{CBO}	$V_{CB}=30V, I_E=0$			0.1	μA
Emitter cut-off current	I_{EBO}	$V_{EB}=5V, I_C=0$			0.1	μA
DC current gain	$h_{FE(1)^*}$	$V_{CE}=2V, I_C=5mA$	40			
	$h_{FE(2)^*}$	$V_{CE}=2V, I_C=150mA$	63		250	
	$h_{FE(3)^*}$	$V_{CE}=2V, I_C=0.5A$	25			
Collector-emitter saturation voltage	$V_{CE(sat)^*}$	$I_C=0.5A, I_B=50mA$			0.5	V
Base-emitter voltage	V_{BE^*}	$V_{CE}=2V, I_C=0.5A$			1	V
Transition frequency	f_T	$V_{CE}=5V, I_C=10mA, f=100MHz$		130		MHz

CLASSIFICATION OF $h_{FE(2)}$

RANK	BCX54 BCX55 BCX56	BCX54-10 BCX55-10 BCX56-10	BCX54-16 BCX55-16 BCX56-16
RANGE	63 - 250	63 - 160	100 - 250

Typical Characteristics

BCX54, BCX55, BCX56

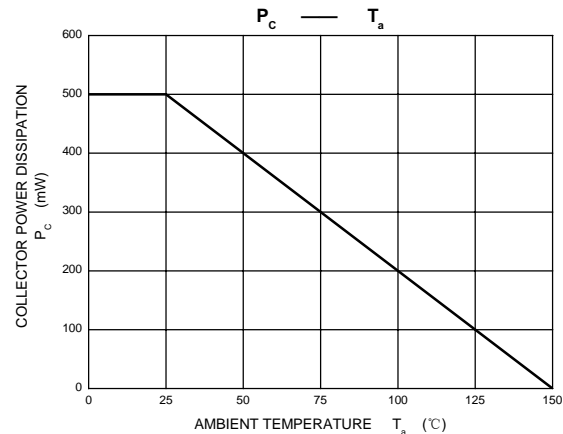
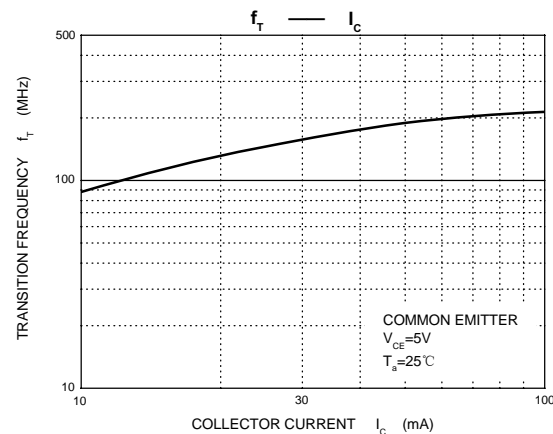
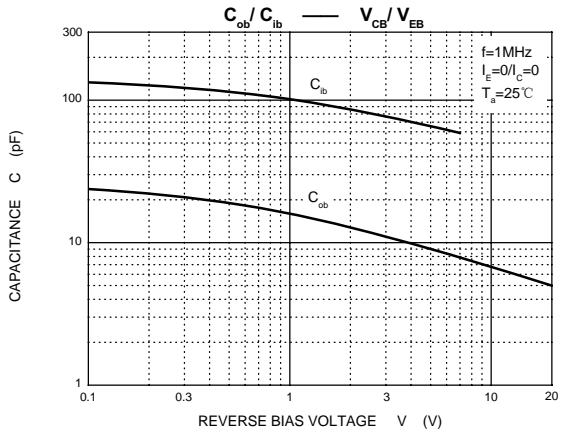
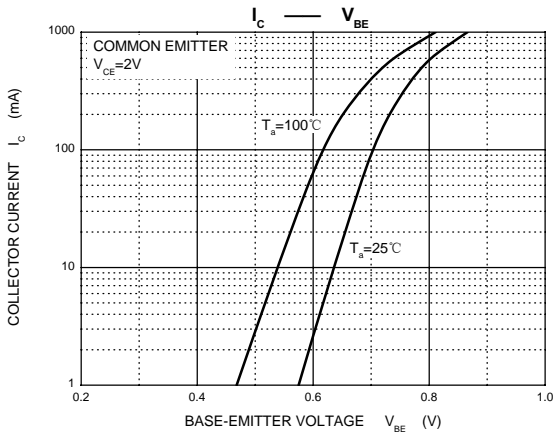
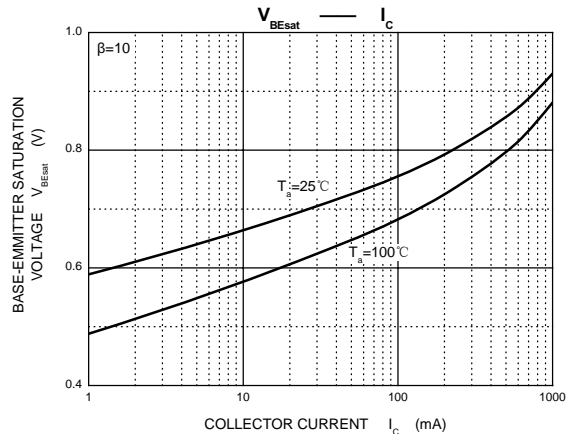
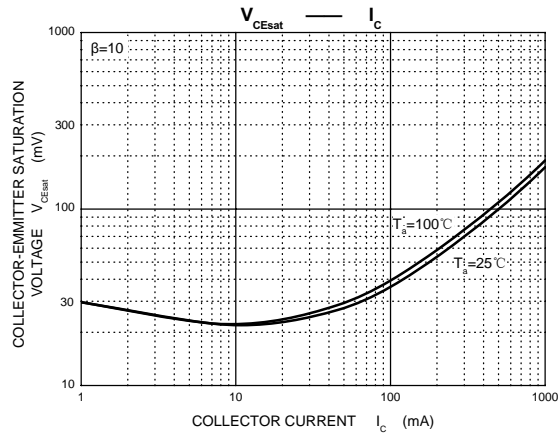
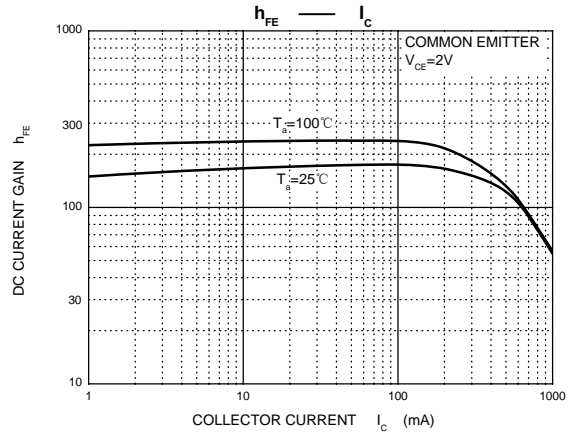
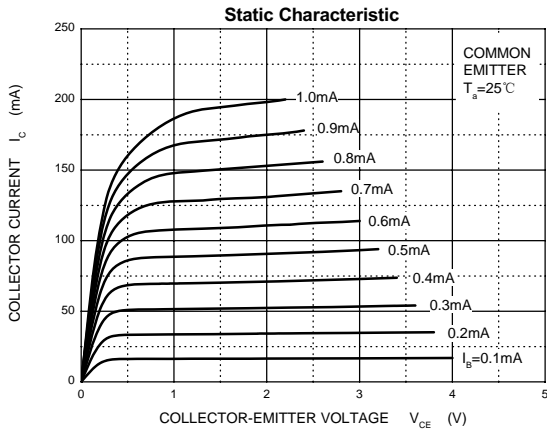

BCX54,BCX55,BCX56

SOT-89 PACKAGE OUTLINE

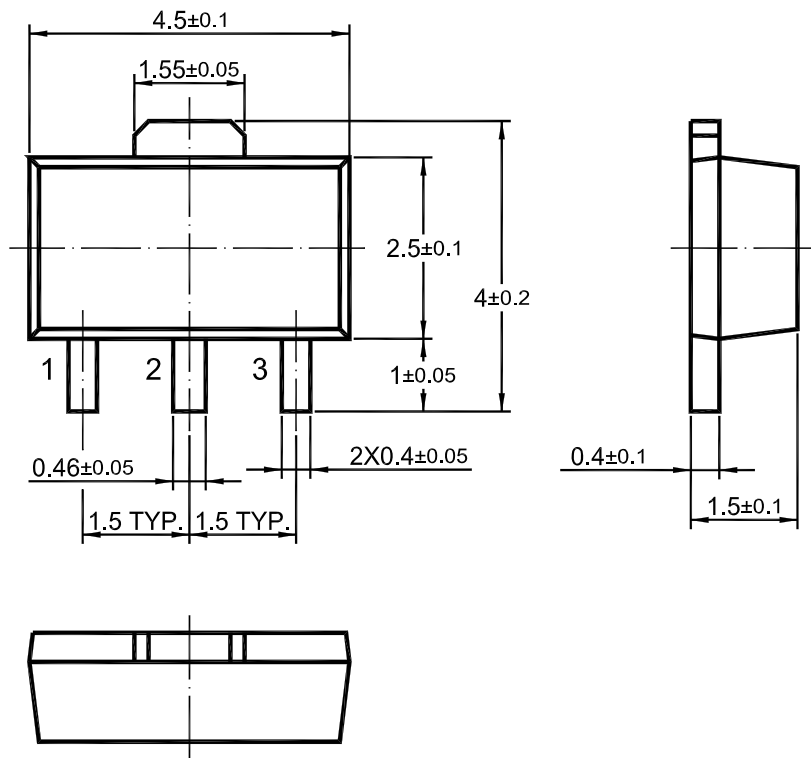

Dimensions in mm