

## SOT-323 Plastic-Encapsulate Transistors

**BC856W** TRANSISTOR (PNP)

**BC857W**

**BC858W**

### FEATURES

- Ideally suited for automatic insertion
- For Switching and AF Amplifier Applications

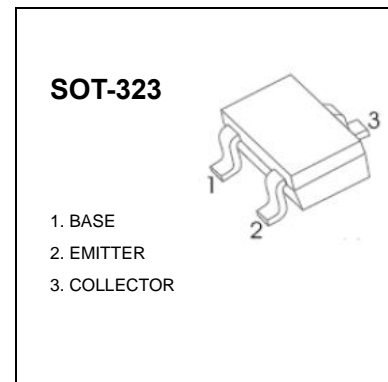

### MAXIMUM RATINGS (T<sub>a</sub>=25°C unless otherwise noted)

Symbol	Parameter	Value	Unit
V <sub>CBO</sub>	Collector-Base Voltage		
	BC856W	-80	V
	BC857W	-50	
	BC858W	-30	
V <sub>CEO</sub>	Collector-Emitter Voltage		
	BC856W	-65	V
	BC857W	-45	
	BC858W	-30	
V <sub>EBO</sub>	Emitter-Base Voltage	-5	V
I <sub>C</sub>	Collector Current –Continuous	-0.1	A
P <sub>C</sub>	Collector Power Dissipation	150	mW
T <sub>J</sub>	Junction Temperature	150	°C
T <sub>stg</sub>	Storage Temperature	-65-150	°C

### DEVICE MARKING

BC856AW=3A; BC856BW=3B;  
 BC857AW=3E; BC857BW=3F; BC857CW=3G;  
 BC858AW=3J; BC858BW=3K; BC858CW=3L

**ELECTRICAL CHARACTERISTICS ( $T_a=25^{\circ}\text{C}$  unless otherwise specified)**

Parameter	Symbol	Test conditions	Min	Max	Unit
Collector-base breakdown voltage BC856W BC857W BC858W	$V_{CBO}$	$I_C = -10\mu\text{A}, I_E = 0$	-80 -50 -30		V
Collector-emitter breakdown voltage BC856W BC857W BC858W	$V_{CEO}$	$I_C = -10\text{mA}, I_B = 0$	-65 -45 -30		V
Emitter-base breakdown voltage	$V_{EBO}$	$I_E = -1\mu\text{A}, I_C = 0$	-5		V
Collector cut-off current	$I_{CBO}$	$V_{CB} = -30\text{V}, I_E = 0$		-15	nA
DC current gain BC856AW, 857AW, 858AW BC856BW, 857BW, 858BW BC857CW, BC858CW	$h_{FE}$	$V_{CE} = -5\text{V}, I_C = -2\text{mA}$	125 220 420	250 475 800	
Collector-emitter saturation voltage	$V_{CE(sat)}$	$I_C = -100\text{mA}, I_B = -5\text{mA}$		-0.65	V
Base-emitter saturation voltage	$V_{BE(sat)}$	$I_C = -100\text{mA}, I_B = -5\text{mA}$		-1.1	V
Transition frequency	$f_T$	$V_{CE} = -5\text{V}, I_C = -10\text{mA}$ $f = 100\text{MHz}$	100		MHz
Collector capacitance	$C_{ob}$	$V_{CB} = -10\text{V}, f = 1\text{MHz}$		4.5	pF

# Typical Characteristics

## BC856W

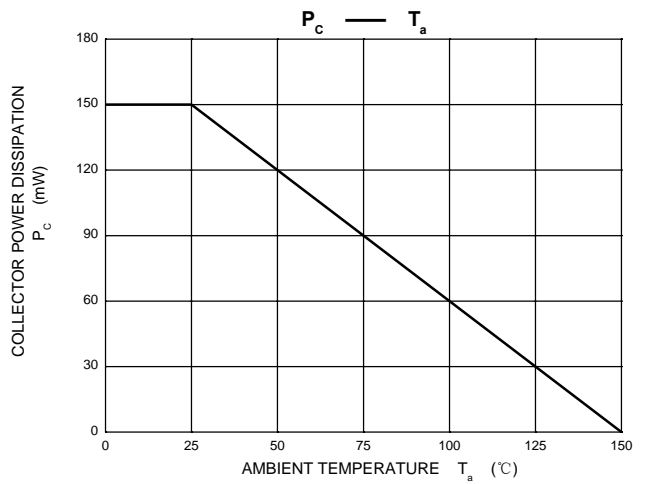
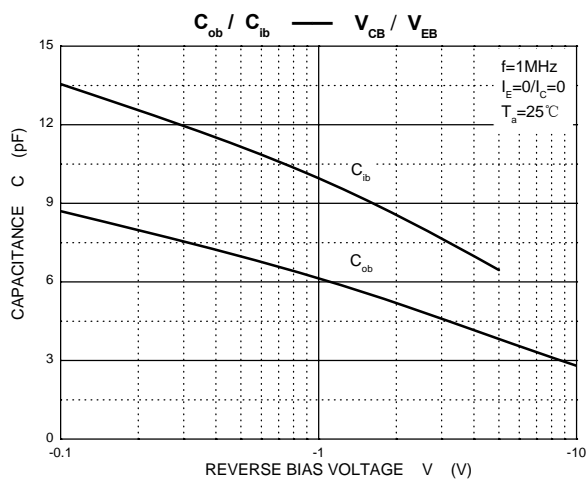
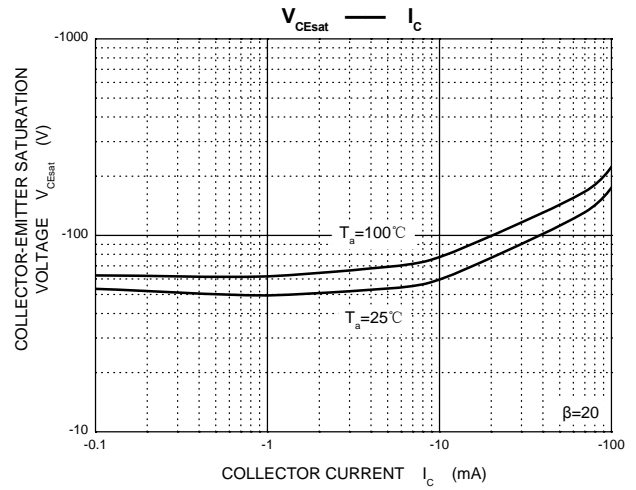
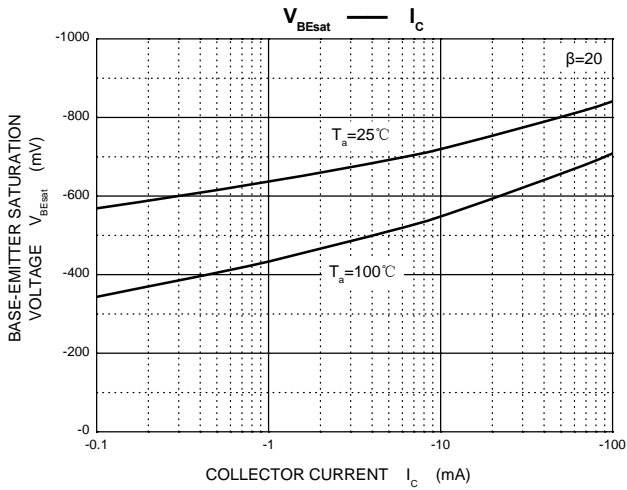
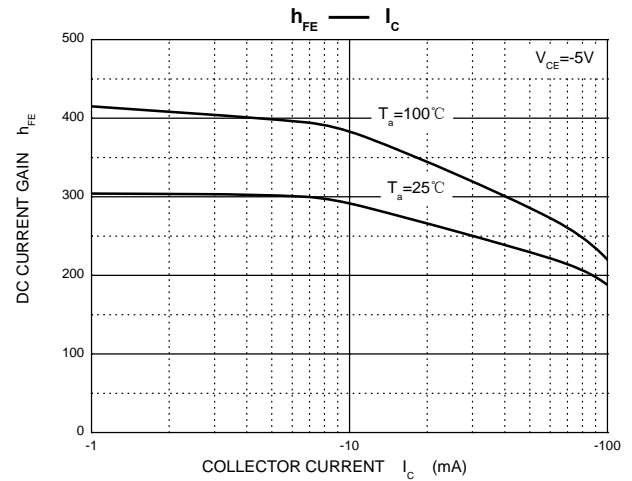
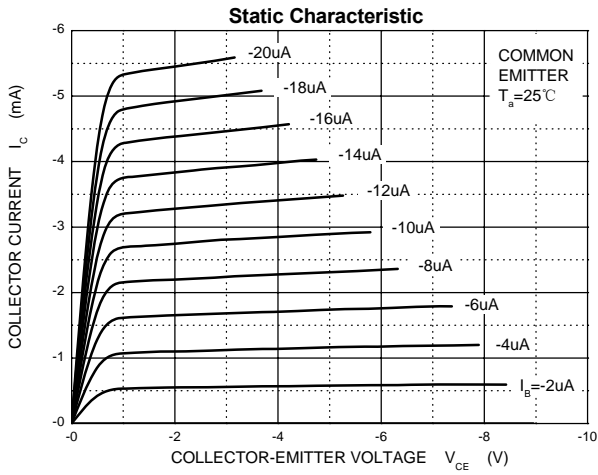

### SOT-323 PACKAGE OUTLINE DIMENSIONS

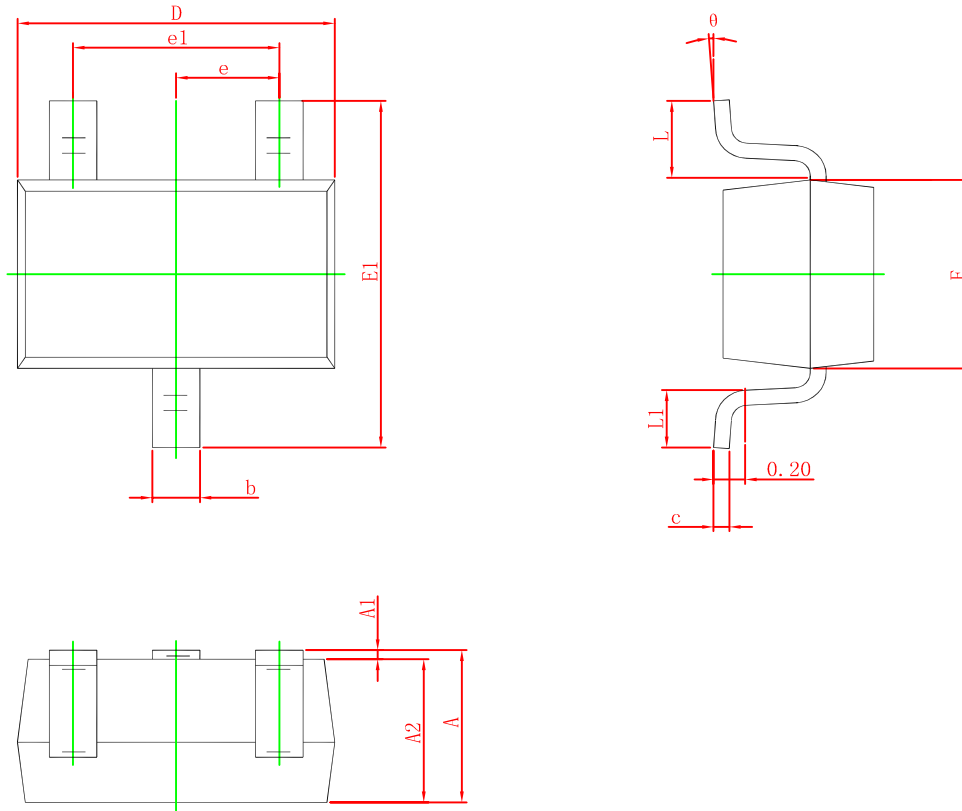

Symbol	Dimensions In Millimeters		Dimensions In Inches	
	Min.	Max.	Min.	Max.
A	0.900	1.100	0.035	0.043
A1	0.000	0.100	0.000	0.004
A2	0.900	1.000	0.035	0.039
b	0.200	0.400	0.008	0.016
c	0.080	0.150	0.003	0.006
D	2.000	2.200	0.079	0.087
E	1.150	1.350	0.045	0.053
E1	2.150	2.450	0.085	0.096
e	0.650 TYP.		0.026 TYP.	
e1	1.200	1.400	0.047	0.055
L	0.525 REF.		0.021 REF.	
L1	0.260	0.460	0.010	0.018
θ	0°	8°	0°	8°