

## 2SB1132U

### PNP SILICON EPITAXIAL MEDIUM POWER TRANSISTOR

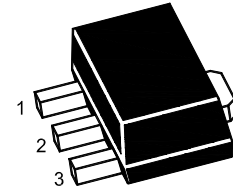

1.Base 2.Collector 3.Emitter  
SOT-89 Plastic Package

#### Absolute Maximum Ratings ( $T_a = 25^\circ\text{C}$ )

Parameter	Symbol	Value	Unit
Collector Base Voltage	$-V_{CBO}$	40	V
Collector Emitter Voltage	$-V_{CEO}$	32	V
Emitter Base Voltage	$-V_{EBO}$	5	V
Collector Current - DC	$-I_C$	1	A
Collector Current - Pulse <sup>1)</sup>	$-I_{CP}$	2	A
Total Power Dissipation	$P_{tot}$	0.5 2 <sup>2)</sup>	W
Junction Temperature	$T_J$	150	$^\circ\text{C}$
Storage Temperature Range	$T_{Stg}$	- 55 to + 150	$^\circ\text{C}$

<sup>1)</sup> Single pulse, PW = 100 ms.

<sup>2)</sup> When mounted on a 40 X 40 X 0.7 mm ceramic board.

#### Characteristics at $T_a = 25^\circ\text{C}$

Parameter	Symbol	Min.	Typ.	Max.	Unit
DC Current Gain at $-V_{CE} = 3\text{ V}$ , $-I_C = 100\text{ mA}$ Current Gain Group	P	82	-	180	-
	Q	120	-	270	-
	R	180	-	390	-
Collector Base Breakdown Voltage at $-I_C = 50\ \mu\text{A}$	$-V_{(BR)CBO}$	40	-	-	V
Collector Emitter Breakdown Voltage at $-I_C = 1\text{ mA}$	$-V_{(BR)CEO}$	32	-	-	V
Emitter Base Breakdown Voltage at $-I_E = 50\ \mu\text{A}$	$-V_{(BR)EBO}$	5	-	-	V
Collector Cutoff Current at $-V_{CB} = 20\text{ V}$	$-I_{CBO}$	-	-	0.5	$\mu\text{A}$
Emitter Cutoff Current at $-V_{EB} = 4\text{ V}$	$-I_{EBO}$	-	-	0.5	$\mu\text{A}$
Collector Emitter Saturation Voltage at $-I_C = 500\text{ mA}$ , $-I_B = 50\text{ mA}$	$-V_{CE(sat)}$	-	-	0.5	V
Transition Frequency at $I_E = 50\text{ mA}$ , $-V_{CE} = 5\text{ V}$ , $f = 30\text{ MHz}$	$f_T$	-	150	-	MHz
Output Capacitance at $-V_{CB} = 10\text{ V}$ , $f = 1\text{ MHz}$	$C_{ob}$	-	-	30	pF

# 2SB1132U

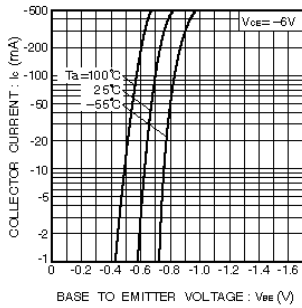

Fig. 1 Grounded emitter propagation characteristics

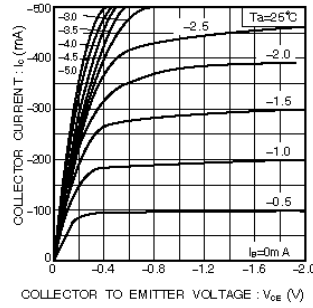

Fig. 2 Grounded emitter output characteristics

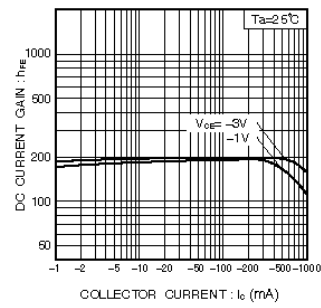

Fig. 3 DC current gain vs. collector current(I)

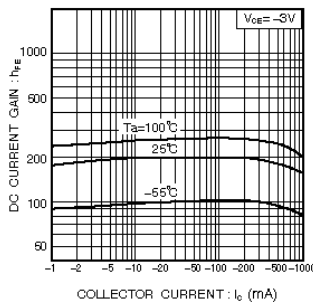

Fig. 4 DC current gain vs. collector current(II)

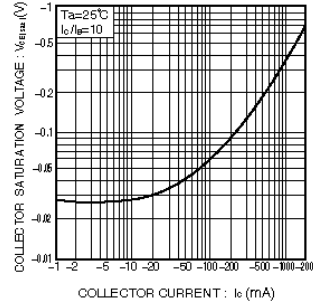

Fig. 5 Collector-emitter saturation voltage vs. collector current

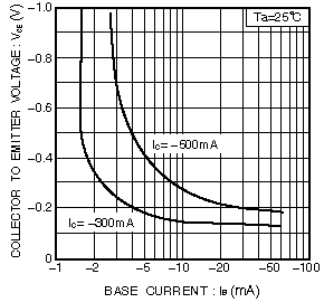

Fig. 6 Collector-emitter saturation voltage vs. base current

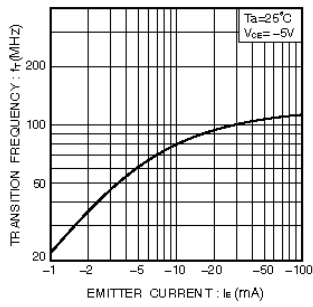

Fig. 7 Gain bandwidth product vs. emitter current

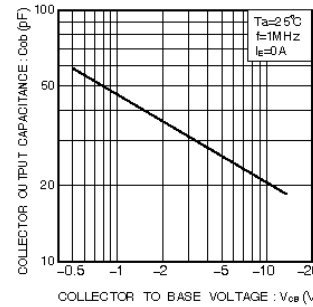

Fig. 8 Collector output capacitance vs. collector-base voltage

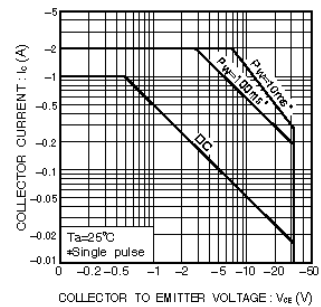

Fig. 9 Safe operation area

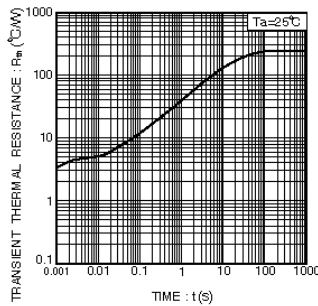
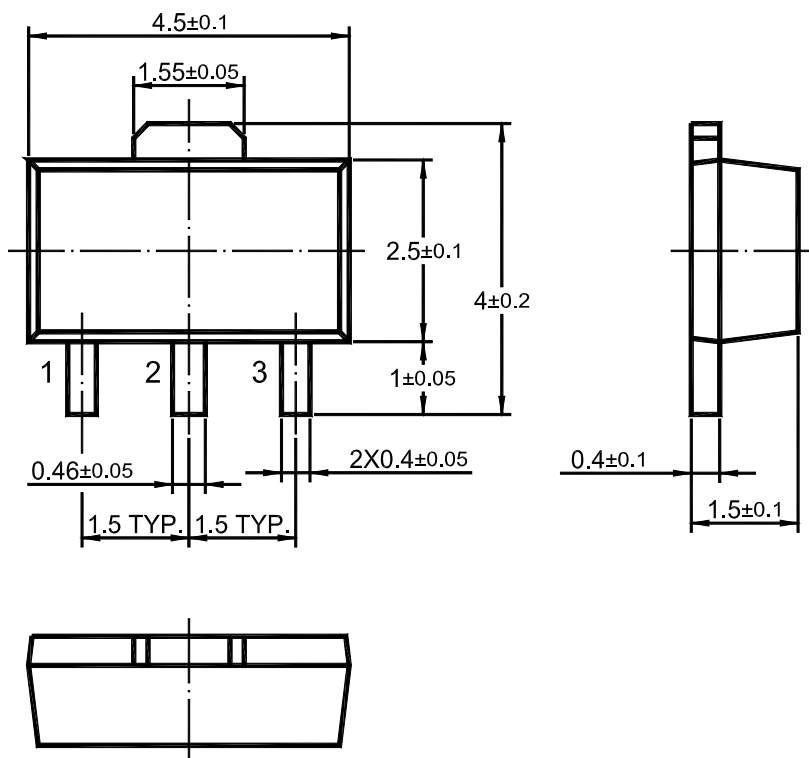

Fig. 10 Transient thermal resistance

## 2SB1132U

### SOT-89 PACKAGE OUTLINE



Dimensions in mm