

2SB1386U

PNP Silicon Epitaxial Planar Transistor

Low frequency transistor

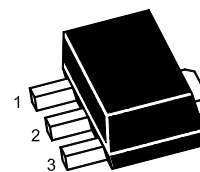

1.Base 2.Collector 3.Emitter
SOT-89 Plastic Package

Absolute Maximum Ratings ($T_a = 25\text{ }^\circ\text{C}$)

Parameter	Symbol	Value	Unit
Collector Base Voltage	$-V_{CBO}$	30	V
Collector Emitter Voltage	$-V_{CEO}$	20	V
Emitter Base Voltage	$-V_{EBO}$	6	V
Collector Current - DC	$-I_C$	5	A
Collector Current - Pulse ¹⁾	$-I_{CP}$	10	A
Collector Power Dissipation	P_C	0.5 2 ²⁾	W
Junction Temperature	T_j	150	$^\circ\text{C}$
Storage Temperature Range	T_{stg}	- 55 to + 150	$^\circ\text{C}$

¹⁾ Single pulse, $P_W = 10\text{ ms}$.

²⁾ When mounted on a 40 X 40 X 0.7 mm ceramic board.

Characteristics at $T_a = 25\text{ }^\circ\text{C}$

Parameter	Symbol	Min.	Typ.	Max.	Unit	
DC Current Gain at $-V_{CE} = 2\text{ V}$, $-I_C = 500\text{ mA}$	Current Gain Group P	h_{FE}	82	-	180	-
	Q	h_{FE}	120	-	270	-
	R	h_{FE}	180	-	390	-
Collector Base Cutoff Current at $-V_{CB} = 20\text{ V}$	$-I_{CBO}$	-	-	500	nA	
Emitter Base Cutoff Current at $-V_{EB} = 5\text{ V}$	$-I_{EBO}$	-	-	500	nA	
Collector Base Breakdown Voltage at $-I_C = 50\text{ }\mu\text{A}$	$-V_{(BR)CBO}$	30	-	-	V	
Collector Emitter Breakdown Voltage at $-I_C = 1\text{ mA}$	$-V_{(BR)CEO}$	20	-	-	V	
Emitter Base Breakdown Voltage at $-I_E = 50\text{ }\mu\text{A}$	$-V_{(BR)EBO}$	6	-	-	V	
Collector Emitter Saturation Voltage at $-I_C = 4\text{ A}$, $-I_B = 100\text{ mA}$	$-V_{CE(sat)}$	-	-	1	V	
Transition Frequency at $-V_{CE} = 6\text{ V}$, $I_E = 50\text{ mA}$, $f = 100\text{ MHz}$	f_T	-	120	-	MHz	
Output Capacitance at $-V_{CB} = 20\text{ V}$, $I_E = 0$, $f = 1\text{ MHz}$	C_{ob}	-	60	-	pF	

2SB1386U

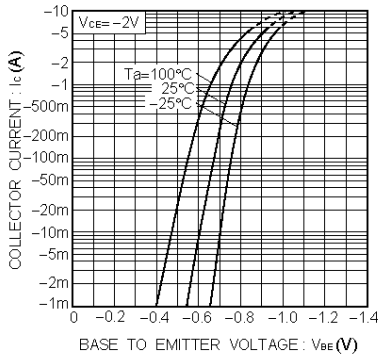

Fig.1 Grounded emitter propagation characteristics

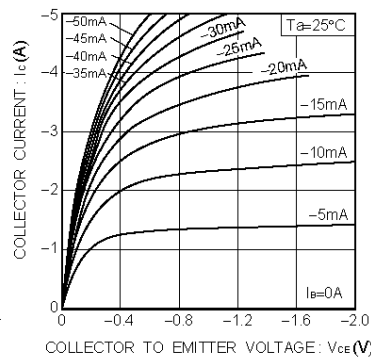

Fig.2 Grounded emitter output characteristics

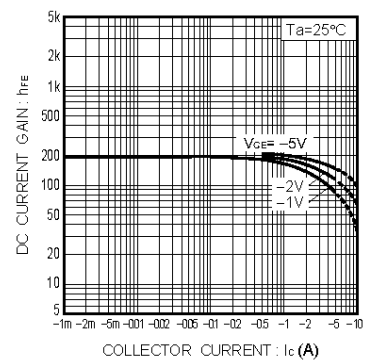

Fig.3 DC current gain vs. collector current (I)

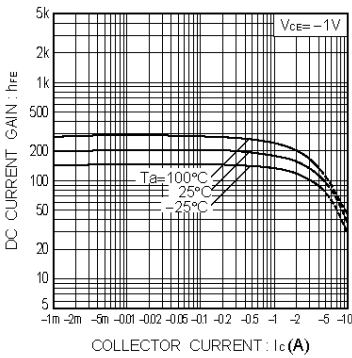

Fig.4 DC current gain vs. collector current (II)

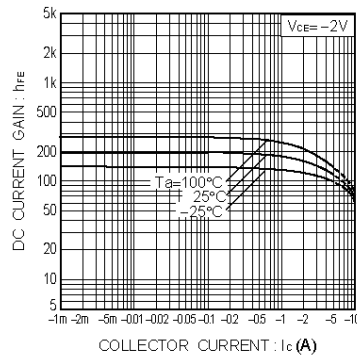

Fig.5 DC current gain vs. collector current (III)

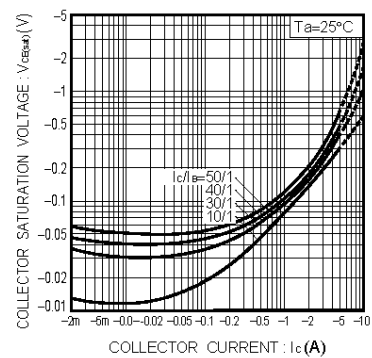

Fig.6 Collector-emitter saturation voltage vs. collector current (I)

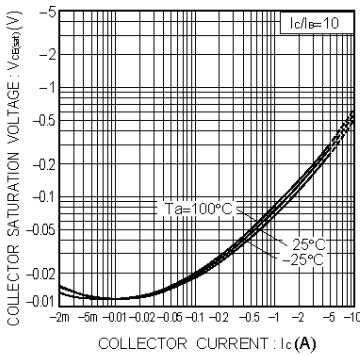

Fig.7 Collector-emitter saturation voltage vs. collector current (II)

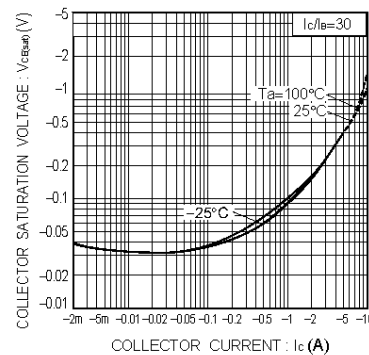

Fig.8 Collector-emitter saturation voltage vs. collector current (III)

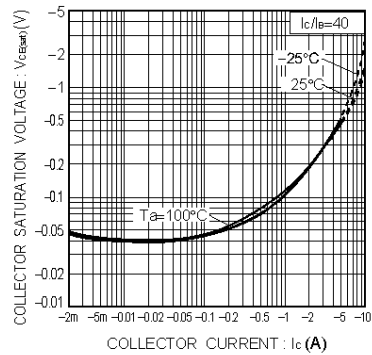
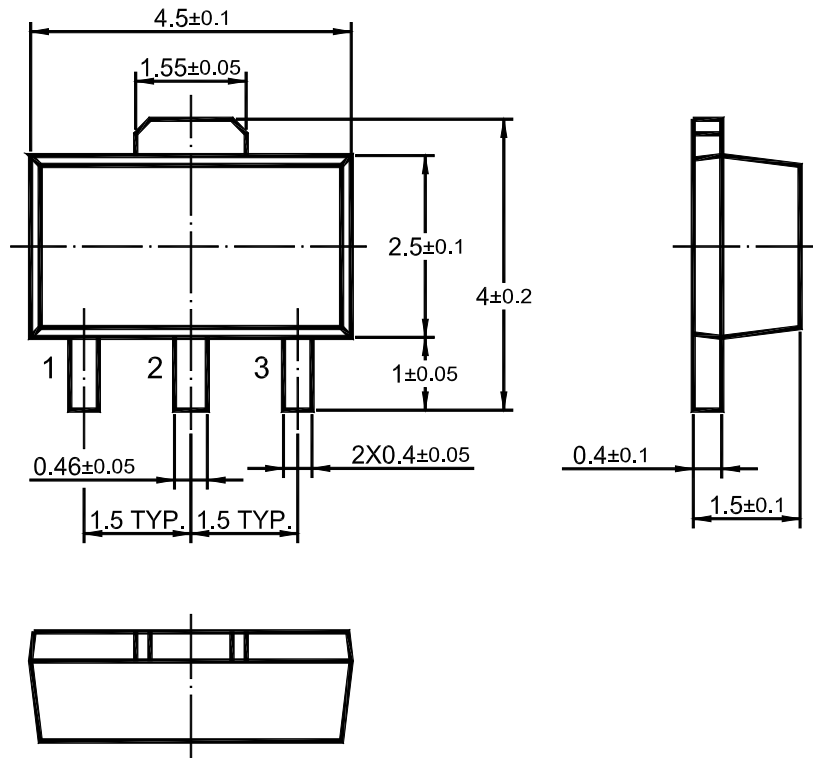

Fig.9 Collector-emitter saturation voltage vs. collector current (IV)

2SB1386U

SOT-89 PACKAGE OUTLINE



Dimensions in mm